

Mainsail: 5000112 Frank -1 Main v2.des

Design Info
=====

Design File:
D:\dropbox\Dropbox\Fareast Sails\2021\5000112 Frank\5000112 Frank -1 Main v2.des

Initial Design Date: 29/1/2021
Boat:

Comments:

Client:

Design Data
=====

Main

Measurements

Luff geodesic: 46.161Ft
 Leech geodesic: 48.225Ft
 Foot geodesic: 15.268Ft
 Head geodesic: 0.377Ft
 Upper width (MUW): 2.729Ft
 Three-quarter width (MTW): 5.079Ft
 Half width (MHW): 9.221Ft
 Quarter width (MQW): 12.506Ft
 Foot median: 47.245Ft
 ORC Mainsail area: 399.610Ft?
 Surface area: 409.008Ft?
 Clew height: 290.354Ft
 Mast rake: 0.000Ft

Battens

Position	Length	Roach	Angle	Luff	Leech	Full
80.000%	3.208Ft	0.595Ft	73.490?	36.916Ft	38.477Ft	
60.000%	4.582Ft	0.820Ft	73.490?	27.689Ft	28.858Ft	
40.000%	4.582Ft	0.742Ft	73.490?	18.463Ft	19.239Ft	
20.000%	4.593Ft	0.428Ft	73.490?	9.239Ft	9.619Ft	

Reefing Points

- 1, Luff: 6.922Ft; Leech: 7.169Ft; Offset: 0.000Ft; Number Eyelets: 3
- 2, Luff: 13.845Ft; Leech: 14.338Ft; Offset: 0.000Ft; Number Eyelets: 3
- 3, Luff: 20.768Ft; Leech: 21.516Ft; Offset: 0.000Ft; Number Eyelets: 3

Luff Curve

		Fanned Luff (@ 5.00% [0.760Ft])	Before BSeam
46.160Ft,	0.000Ft	100% (46.161Ft) :	0.000Ft
40.408Ft,	-0.097Ft	90% (41.546Ft) :	0.177Ft
34.620Ft,	-0.167Ft	80% (36.929Ft) :	0.349Ft
28.818Ft,	-0.203Ft	70% (32.313Ft) :	0.489Ft
23.080Ft,	-0.210Ft	60% (27.697Ft) :	0.572Ft
17.200Ft,	-0.194Ft	50% (23.081Ft) :	0.590Ft
11.540Ft,	-0.155Ft	40% (18.465Ft) :	0.542Ft
5.752Ft,	-0.088Ft	30% (13.848Ft) :	0.442Ft
0.000Ft,	0.000Ft	20% (9.232Ft) :	0.307Ft
		10% (4.617Ft) :	0.149Ft
		0% (0.000Ft) :	0.000Ft

Mainsail: 5000112 Frank -1 Main v2.des

Seam Allowances			
Zone: 1	Split	Radial	Cross
	0.000Ft	0.000Ft	0.197Ft

Edge Excesses			
Sail:	Luff	Leech	Foot
	0.000Ft	0.000Ft	0.000Ft

Total Seam Lengths (Ft)

Horizontal	44.60
Radial/Vertical	0.00
Bi-Radial Split	0.00

Materials

Material	Area (Ft ²)	Panels
Material 1	408.77	1,2,3,4,5 6

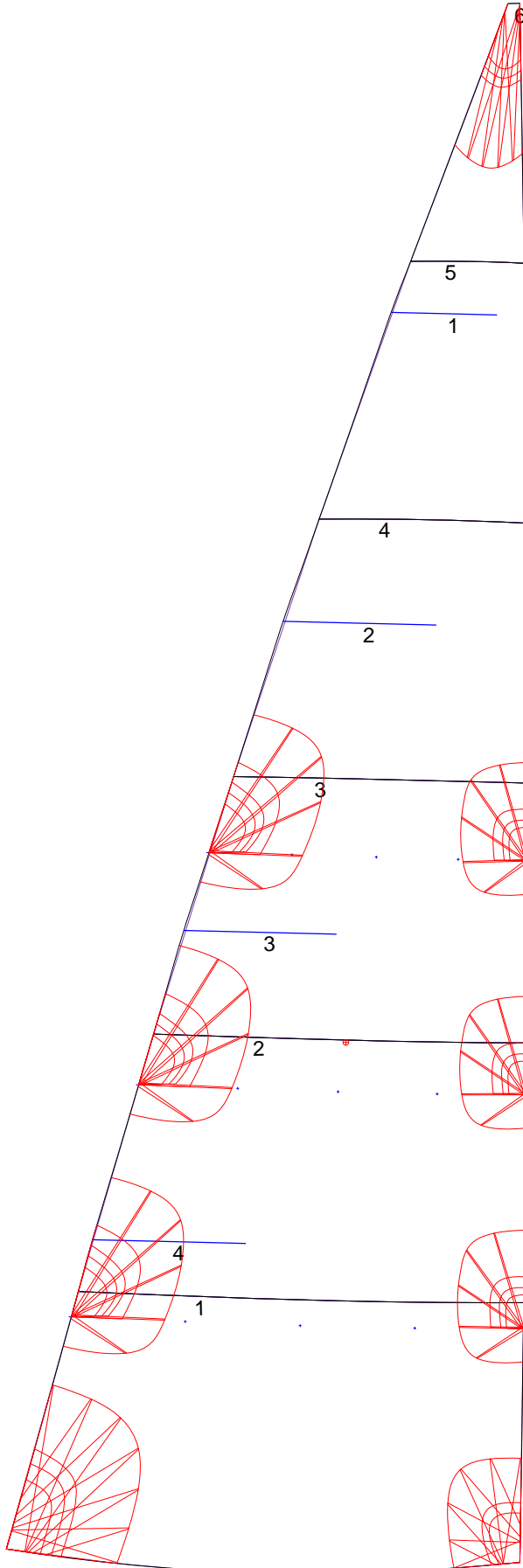

Mainsail: 5000112 Frank -1 Main v2.des

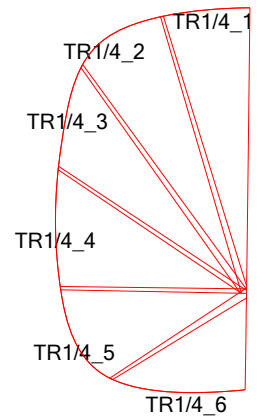
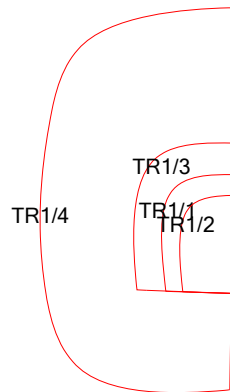
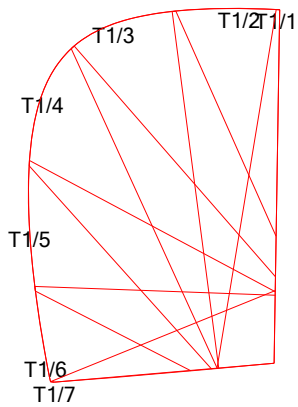
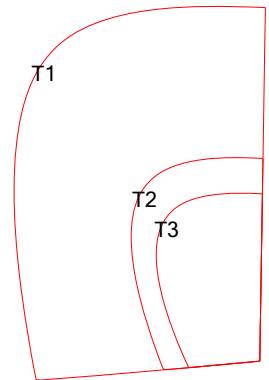
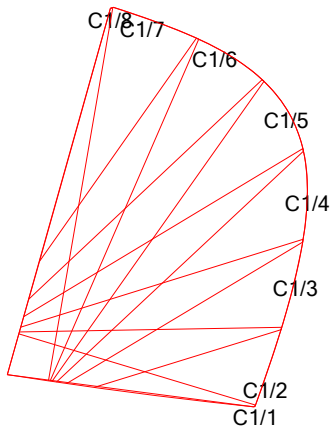
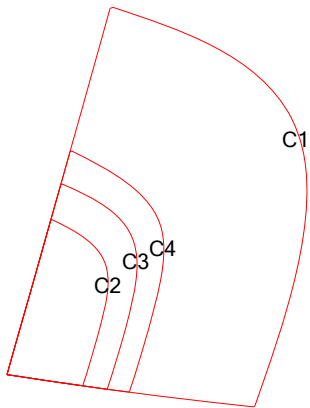
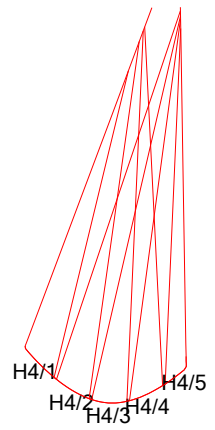
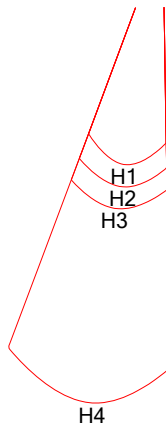
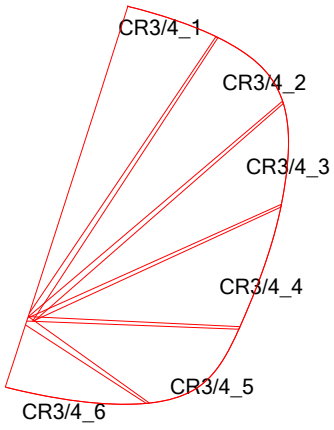
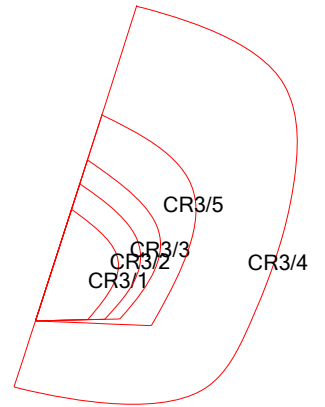
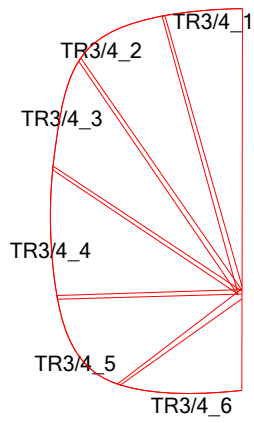
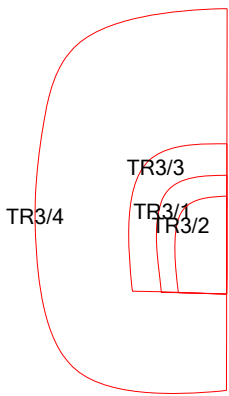

Mainsail: 5000112 Frank -1 Main v2.des

