



Date: 14/03/2024

Designer: BIFA

Company: Far east

Filename: 8000303-3 Bart Lagoon 620 jib(stay sail) pak

Sail:

Boat: lagoon 620

Customer:

Order Ref.:

Panel layout

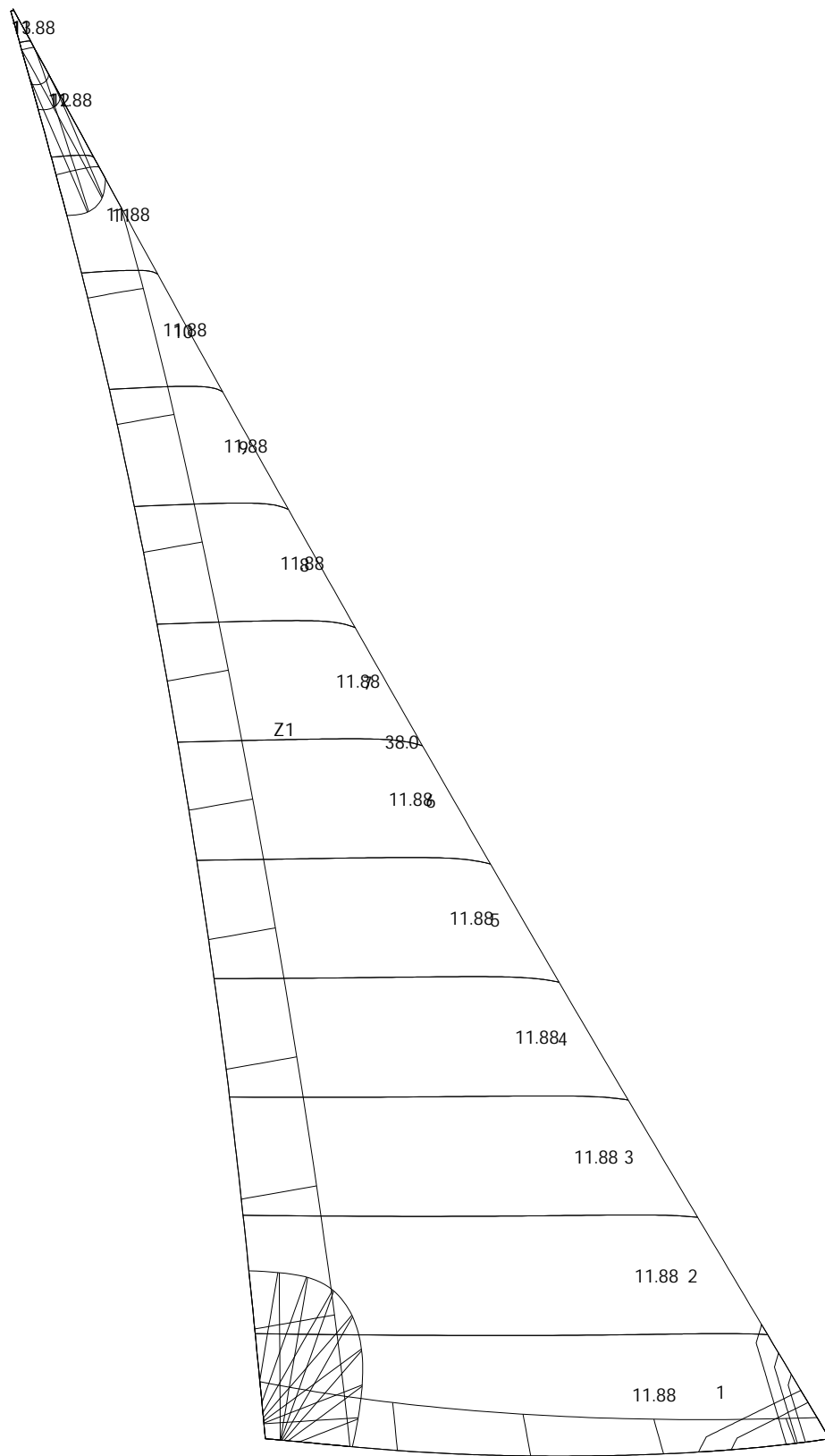



Date: 14/03/2024

Designer: BIFA

Company: Far east

Filename: 8000303-3 Bart Lagoon 620 jib(stay sail) pak

Sail:

Boat: lagoon 620

Customer:

Order Ref.:

Patch layout

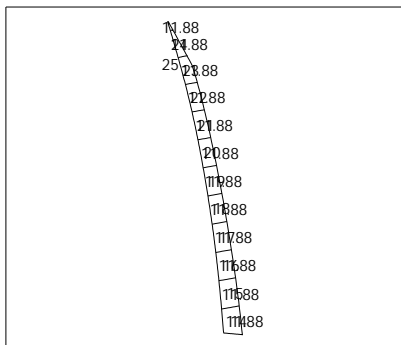

P2

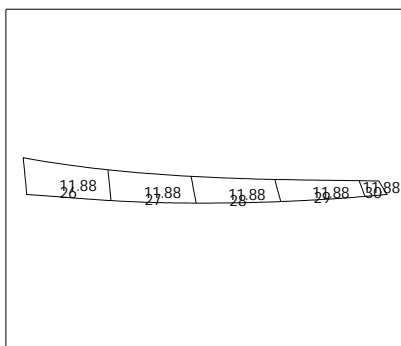

P3

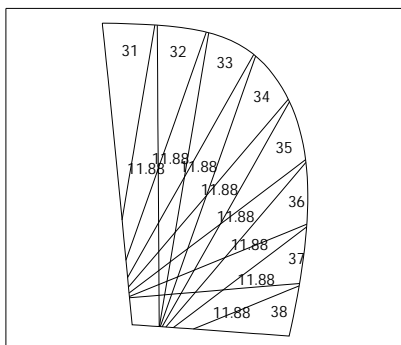

P4





Date: 14/03/2024
 Designer: BIFA
 Company: Far east
 Filename: 8000303-3 Bart Lagoon 620 jib(stay sail) pak

Sail:
 Boat: lagoon 620
 Customer:
 Order Ref.:

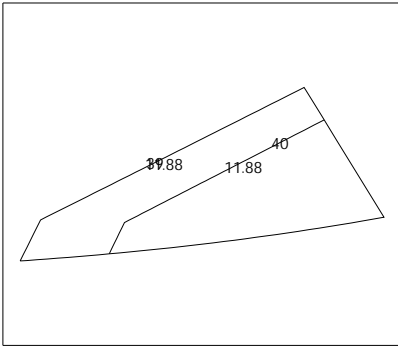

P5

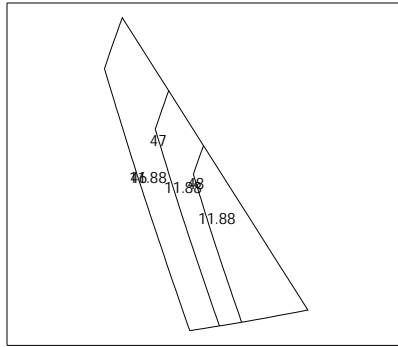

P8

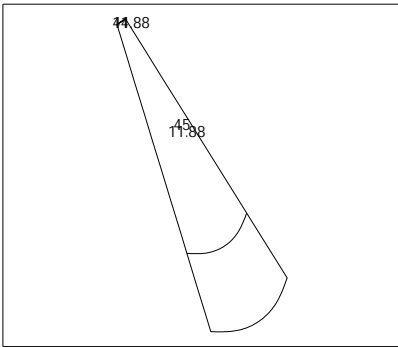

P7

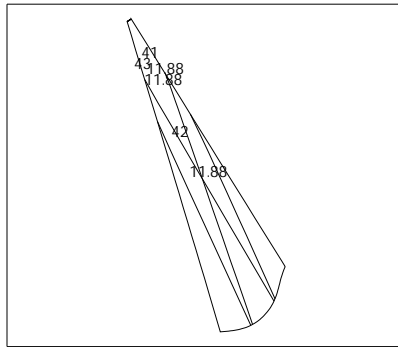

P6





Date: 14/03/2024

Designer: BIFA

Company: Far east

Filename: 8000303-3 Bart Lagoon 620 jib(stay sail) pak

Sail:

Boat: lagoon 620

Customer:

Order Ref.:

Measurement Check List

Measurement rules Ref.: Outline

[Luff] = 18.060 m [Leech] = 16.015 m [Foot] = 6.261 m [Head] = 0.038 m Area = 47.066 m2

Angles (Flat on the floor) Clew: 99.37 i ª Tack: 67.97 i ª Head: 15.72 i ª

Roach (After broadseaming)

	1/8	2/8	3/8	4/8	5/8	6/8	7/8
Luff	-59.8 mm	-106.3 mm	-132.3 mm	-139.3 mm	-130.5 mm	-103.6 mm	-56.9 mm
Leech	-176.2 mm	-314.3 mm	-393.4 mm	-418.4 mm	-393.3 mm	-312.3 mm	-174.5 mm

Reef, Battens, Shape stripes

Area & Weight

Sail area: 47.07 m2 Reefed: No reef

Material area: 69.22 m2 Material weight: ??? Total weight: ???

Materials

Material's ID	Material's ref. (&color)	Area (m2)	Mass (gr)	Panels
11.88	Default	69.220		1-13 14-48

Seam width

Seam width (mm)	Zones; Total length (m)
38.0	Zones: Z1; TOTAL: 32.9m

Sail outline finishings

Hemmings: None

Outline drawings: None

Notes

