

## Panel layout

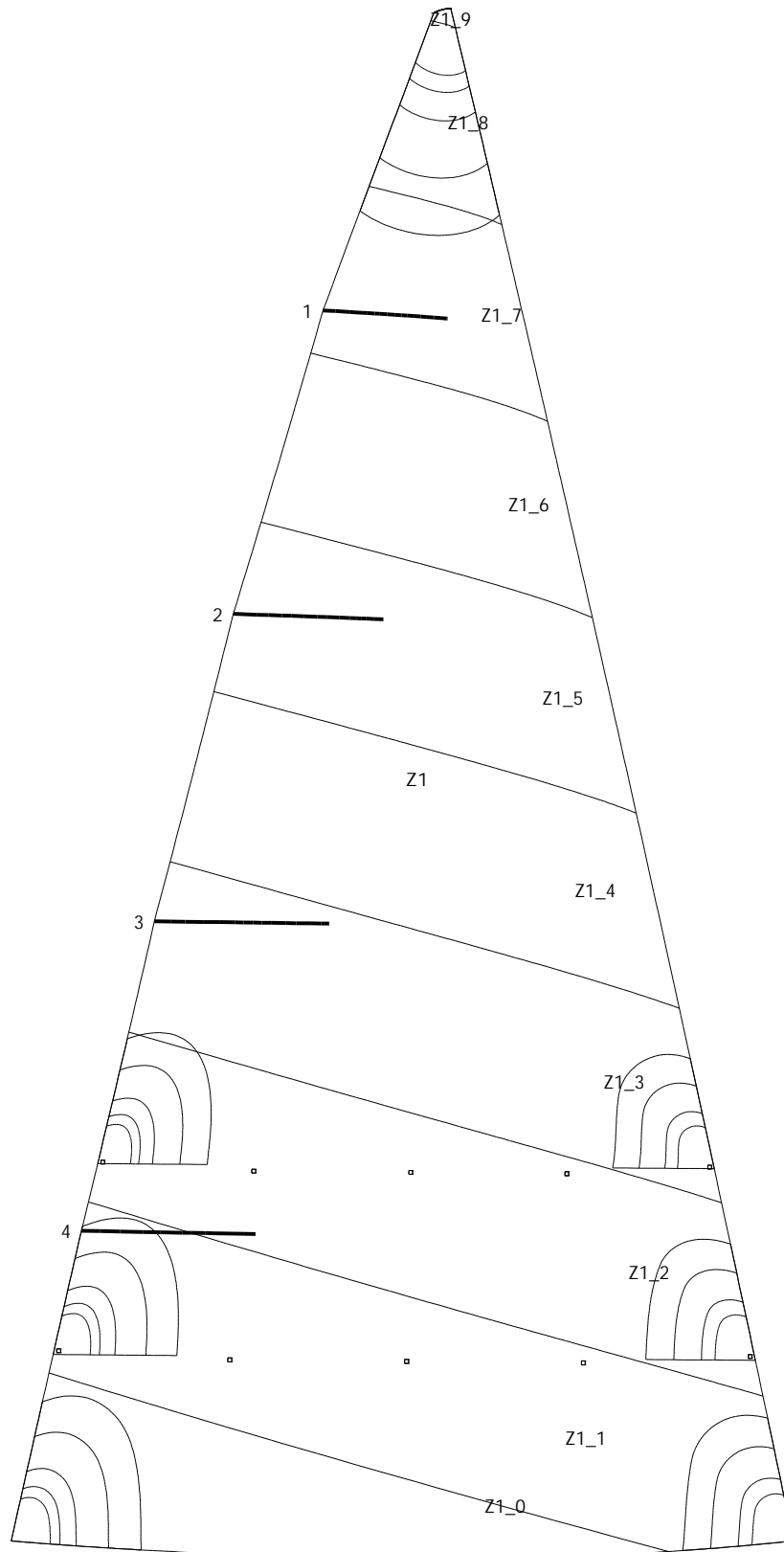

## Patch layout

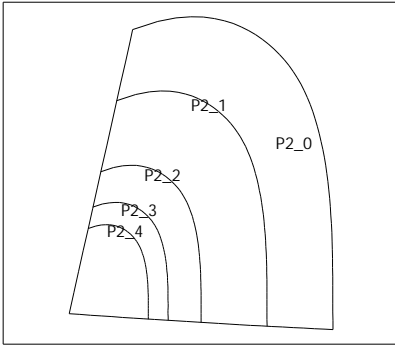

P2

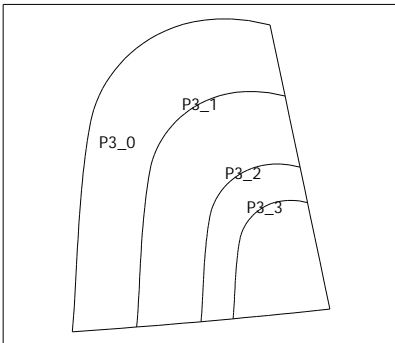

P3

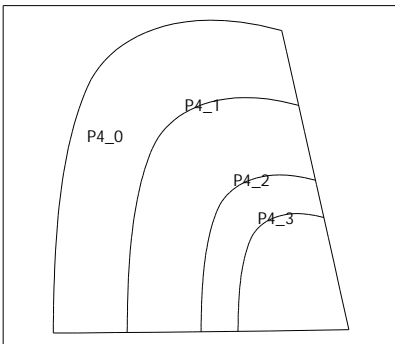

P4

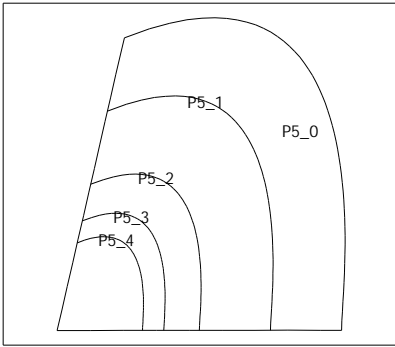

P5

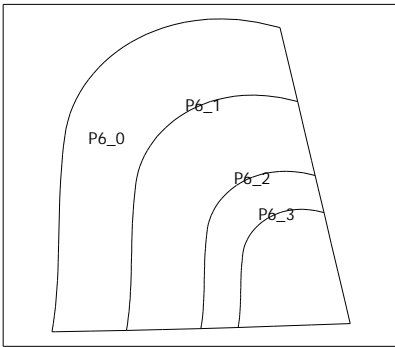

P6

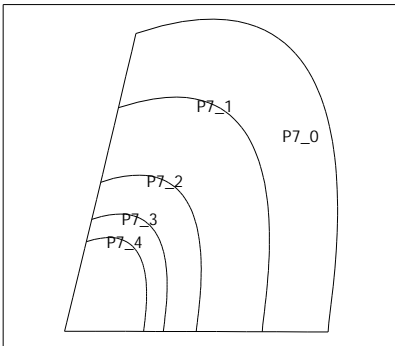

P7

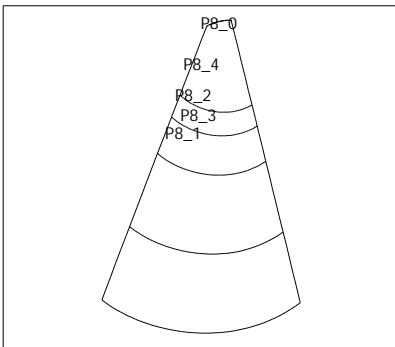

P8

Date: 2/01/2017  
 Designer:  
 Company:  
 Filename: Nonsuch 26.pak

**Sail:**  
**Boat:**  
**Customer:**  
 Order Ref.:

## Measurement Check List

### Measurement rules Ref.: Main\_IRC

[Luff] = 12.495 m [chordleech] = 12.751 m [Head] = 0.150 m [MGM] = 3.481 m [MGT] = 1.027 m  
 [MGU] = 1.916 m [MGL] = 4.881 m Area = 43.183 m<sup>2</sup> MGMmax = 4.06 MGUmax = 2.37 MGTmax = 1.37  
 [median] = 12.401 m [E] = 6.248 m

**Angles** Clew: 81.26 ° Tack: 83.83 ° Head Fwd: 91.90 ° Head Aft: 128.03 °

### Roach (After broadseaming)

	1/8	2/8	3/8	4/8	5/8	6/8	7/8
Luff	8.8 mm	17.7 mm	24.1 mm	27.0 mm	25.3 mm	18.9 mm	10.3 mm
Leech	57.2 mm	113.1 mm	165.5 mm	207.5 mm	227.9 mm	215.9 mm	153.0 mm

### Reef, Battens, Shape stripes

	Luff (m) (ref: tack)	Leech (m) (ref: clew)	Length (m)
Reef	1.499	1.564	5.648
Reef	3.042	3.114	5.009
Batten	9.885	10.135	1.000
Batten	7.397	7.613	1.200
Batten	4.973	5.086	1.400
Batten	2.478	2.549	1.400

### Area

Material area: 55.98 m<sup>2</sup> Sail area (mould): 43.18 m<sup>2</sup>

### Materials

Material's ID	Material's ref. (&color)	Area (m <sup>2</sup> )	Panels
	Default	55.976	Z1_[0;1;2;3;4;5;6;7;8;9];P2_[0;1;2;3;4]; ...
			... P3_[0;1;2;3];P4_[0;1;2;3];P5_[0;1;2;3;4]; ...
			... P6_[0;1;2;3];P7_[0;1;2;3;4];P8_[0;1;2;3; ...
			... 4]

### Seam width

Seam width (mm)	Zones; Total length (m)
25.0	Zones: Z1; TOTAL: 30.0m

### Sail outline finishings

Hemmings: None

Outline drawings: None

### Notes